





# Prodigy Plus® Modular Cubers Utilizing AquaArmor™ with AgION®

\*Refer to page 18 & 20 for required bin tops.



Unit Dimensions (W x D x H)	Cube Size	Model Number	Condenser Type	24 hr Ice Production		Shipping Weight lb/kg	115/60/1 -1
				70°F/21°C 50°F/10°C lb/kg	Air Water 90°F/32°C 70°F/21°C lb/kg		
 22" x 24" x 23" 55.9 x 61.0 x 58.4 cm	Med. Sm.	<b>C0322</b>	Air	356/162	255/116	145/66	\$5,293 ☆
		C0322MA	Water	366/166	280/127	145/66	\$5,293
		C0322SA	Air	356/162	255/116	145/66	\$5,293 ☆
		C0322SW	Water	366/166	280/127	145/66	\$5,293
	Med. Sm.	<b>C0522</b>	Air	475/216	380/173	160/73	\$5,562
		C0522MA	Water	549/250	480/218	160/73	\$5,562
		C0522SA	Air	475/216	380/173	160/73	\$5,562
		C0522SW	Water	549/250	480/218	160/73	\$5,562
 22" x 24" x 29" 55.9 x 61.0 x 73.7 cm	Med. Sm.	<b>C0722</b>	Air	790/358	590/268	180/82	
		C0722MA	Air	790/358	590/268	180/82	
		C0722SA					

Unit Dimensions (W x D x H)	Cube Size	Model Number	Condenser Type	24 hr Ice Production		Shipping Weight lb/kg	115/60/1 -1
				70°F/21°C 50°F/10°C lb/kg	Air Water 90°F/32°C 70°F/21°C lb/kg		
 30" x 24" x 23" 76.2 x 61.0 x 58.4 cm	Med. Sm.	<b>C0330</b>	Air	350/159	300/136	160/73	\$5,102 ☆
		C0330MA	Water	400/182	300/136	160/73	\$5,102
		C0330SA	Air	350/159	300/136	160/73	\$5,102 ☆
		C0330SW	Water	400/182	300/136	160/73	\$5,102
	Med. Sm.	<b>C0530</b>	Air	525/238	380/172	175/80	\$5,654 ☆
		C0530MA	Remote	500/227	400/181	175/80	\$5,554
		C0530MR	Water	500/227	410/186	175/80	\$5,654
		C0530MW	Air	525/238	380/172	175/80	\$5,654 ☆
		C0530SA	Remote	500/227	400/181	175/80	\$5,554
		C0530SR	Water	500/227	410/186	175/80	\$5,654

Unit Dimensions (W x D x H)	Cube Size	Model Number	Condenser Type	24 hr Ice Production		Shipping Weight lb/kg	208-230/60/1 -32
				70°F/21°C 50°F/10°C lb/kg	Air Water 90°F/32°C 70°F/21°C lb/kg		
 30" x 24" x 23" 76.2 x 61.0 x 58.4 cm	Med. Sm.	<b>C0630</b>	Air	776/353	528/240	190/86	\$6,814
		C0630MA	Remote	684/311	616/280	190/86	\$6,714
		C0630MR	Water	722/328	650/295	190/86	\$6,814
		C0630MW	Air	776/353	528/240	190/86	\$6,814
		C0630SA	Remote	684/311	616/280	190/86	\$6,714
		C0630SR	Water	722/328	650/295	190/86	\$6,814
		C0630SW					
		C0630S					

☆ = Energy Star certified. ● = CE Approved.

4. Combine model number and electrical indicator when ordering for exact SKU, i.e. C0322MA-1. See page 16 for storage bins.

# Prodigy Plus® Modular Cubers Utilizing AquaArmor™ with AgION®

Unit Dimensions (W x D x H)	Cube Size	Model Number	Condenser Type	24 hr Ice Production		Shipping Weight	208-230/60/1 -32	
				70°F/21°C 50°F/10°C lb/kg	Air Water lb/kg			90°F/32°C 70°F/21°C lb/kg
 30" x 24" x 29" 76.2 x 61.0 x 73.7 cm	Med.	<b>C0830</b>		Air	905/411	724/329	220/100	\$8,749 ☆
		Remote	870/395	780/355	220/100	\$8,649 ☆		
		Water	924/420	832/378	220/100	\$8,749		
		Air	905/411	724/329	220/100	\$8,749 ☆		
		Remote	870/395	780/355	220/100	\$8,649 ☆		
		Water	924/420	832/378	220/100	\$8,749		
	Sm.	<b>C1030</b>		Air	1077/490	844/384	235/107	\$9,966 ☆
		Remote	996/453	851/387	235/107	\$9,866 ☆		
		Water	996/452	851/386	235/107	\$9,966		
		Air	1077/490	844/384	235/107	\$9,966 ☆		
		Remote	996/453	851/387	235/107	\$9,866 ☆		
		Water	996/452	851/386	235/107	\$9,966		

Unit Dimensions (W x D x H)	Cube Size	Model Number	Condenser Type	24 hr Ice Production		Shipping Weight	208-230/60/1 -32	
				70°F/21°C 50°F/10°C lb/kg	Air Water lb/kg			90°F/32°C 70°F/21°C lb/kg
 48" x 24" x 29" 121.9 x 61.0 x 73.7 cm	Med.	<b>C1448</b>		Air	1553/706	1242/565	345/157	\$11,189
		Remote	1357/617	1221/555	345/157	\$11,089 ☆		
		Water	1444/656	1300/591	345/157	\$11,189		
		Air	1553/706	1242/565	345/157	\$11,189		
		Remote	1357/617	1221/555	345/157	\$11,089 ☆		
		Water	1444/656	1300/591	345/157	\$11,189		
	Sm.	<b>C1848</b>		Air	1909/868	1527/694	355/161	\$14,729
		Remote	1828/831	1645/748	355/161	\$14,629 ☆		
		Air	1909/868	1527/694	355/161	\$14,729		
		Remote	1828/831	1645/748	355/161	\$14,629 ☆		
		Water	1900/864	1710/777	355/161	\$14,729		
		<b>C2148</b>		Remote	2248/1022	1849/840	370/168	\$17,931
	Med.	— C2148MR		Remote	2248/1022	1849/840	370/168	\$17,931
		— C2148SR		Remote	2248/1022	1849/840	370/168	\$17,931

Unit Dimensions (W x D x H)	Cube Size	Model Number	Condenser Type	24 hr Ice Production		Shipping Weight	208-230/60/1 N/A	
				70°F/21°C 50°F/10°C lb/kg	Air Water lb/kg			90°F/32°C 70°F/21°C lb/kg
 48" x 28.5" x 34" 121.9 x 72.39 x 86.36 cm	Med. Sm.	<b>C2648</b>		Remote	2630/1193	2256/1023	430/195	
		— C2648MR		Remote	2630/1193	2224/1009	430/195	
		— C2648SR		Remote	2630/1193	2224/1009	430/195	

☆ = Energy Star certified. ● = CE Approved.

Combine model number and electrical indicator when ordering for exact SKU, i.e. C0322MA-1. See page 16 for storage bins.

# Modular Cuber Kits and Accessories

Unit Dimensions (W x D x H)	Model Number	Description	Shipping Weight lb/kg
22" x 24" x 23" 55.9 x 61.0 x 58.4 cm	<b>Remote Condensers</b> ERC111	Remote condenser for C0522xR or C0530xR	95/43
22" x 24" x 23" 55.9 x 61.0 x 58.4 cm	ERC311	Remote condenser for C0630xR, C0830xR, C1030xR, or C1448xR	130/59
22" x 24" x 23" 55.9 x 61.0 x 58.4 cm	ERC611	Remote condenser for C1848xR or C2148xR	140/84
22" x 24" x 29" 55.9 x 61.0 x 73.7 cm	PRC241	Remote condenser for C2648xR	135/61

Model Number	Description	Shipping Weight lb/kg
<b>Miscellaneous</b>		
KERCF	Air filter for ERC111 or ERC311	5/2
RCKCME6GX	Remote condensing kit for connecting all Prodigy® models to non-Scotsman remote condenser coils	25/11
KTPS-SM	Tamper Proof Screw Kit (incl. Tool) to convert 22" (55.9 cm), 30" (76.2 cm) or 48" (121.9 cm) cuber	5/2
<b>Line Sets</b>		
RTE10	10 ft (3m) precharged R-404A tubing	7/3
RTE25	25 ft (7.6m) precharged R-404A tubing	12/6
RTE40	40 ft (12.2m) precharged R-404A tubing	17/8
RTE75	75 ft (22.9m) precharged R-404A tubing	35/16
KTE4	Tube end kit - contains 4 quick connect fittings for any RTE Line Set	5/2
RTEL25	25 ft (7.6m) precharged R-404A tubing. Use with C2648 remote cooled units	16/7
RTEL40	40 ft (12.2m) precharged R-404A tubing. Use with C2648 remote cooled units	22/10
RTEL75	75 ft (22.9m) precharged R-404A tubing. Use with C2648 remote cooled units	40/18
KTEL4	Tube end kit - contains 4 quick connect fittings for any RTEL Line Set	5/2
<b>Prodigy® Modular Cuber Accessories</b>		
KPAS	Kit - Prodigy Advanced Sustainability. Includes KSBU-N and KVS	10/4
KSBU	Kit - Prodigy Smart-Board™ - Use additional operational data for fast diagnosis	5/2
KSBU-N	Kit - Prodigy Smart-Board™ - Network connection	5/2
KVS	Kit - Prodigy Vari-Smart™ Ice Level Control - Adjust ice levels to match ice needs	5/2
<b>Front Air Kit Flows</b>		
KPMFA223-B	Kit - Prodigy® Front Air Flow, C0322 & C0522 (B revisions only)	11/5
KPMFA303-B	Kit - Prodigy® Front Air Flow, C0330, C0530 & C0630 (B and C revisions only)	13/6
KPMFA309-B	Kit - Prodigy® Front Air Flow, C0830 & C1030 (B revisions only)	15/7

6.

★ = Energy Star certified. ● = CE Approved.

Combine model number and electrical indicator when ordering for exact SKU, i.e. C0322MA-1. See page 16 for storage bins.



**CU0415**



15" x 24" x 32"  
38.1 x 61.0 x 96.5 cm  
(Add 5.5" (14cm) Height for legs)

**CU0715**



15" x 24" x 32"  
38.1 x 61.0 x 96.5 cm  
(Add 5.5" (14cm) Height for legs)

**CU0920**



20" x 24" x 32"  
50.8 x 61.0 x 96.5 cm  
(Add 5.5" (14cm) Height for legs)



Cube Size	Model Number	Condenser Type	24 hr Ice Production		Storage Capacity	Shipping Weight	
			70°F/21°C 50°F/10°C lb/kg	Air Water			
Med.	<b>CU0415</b>	Air	58/26	38/17	36/16	102/46	●
	— CU0415MA						
Med.	<b>CU0715</b>	Air	80/36	58/26	36/16	102/46	●
	— CU0715MA						
Med.	<b>CU0920</b>	Air	100/45	80/36	57/26	115/52	●
	— CU0920MA						
<b>Optional Kits</b>		<b>Description</b>					
KUFM15		For ADA applications. Lowers CU0415 and CU0715 height to 31.9"				3/1	
KUFM20		For ADA applications. Lowers CU920 height to 31.9"				3/1	



## Prodigy® Self-Contained Undercounter Cubers



Unit Dimensions (W x D x H)	Cube Size	Model Number	Condenser Type	24 hr Ice Production		Storage Capacity	Shipping Weight	
				70°F/21°C 50°F/10°C lb/kg	Air Water			
 26" x 27 3/8" x 33" 66.0 x 69.5 x 83.8 cm (Add 6" (15.2cm) Height for legs)	Med. Sm.	<b>CU1526</b>	Air Water Air Water	150/68 175/80 150/68 175/80	110/150 124/156 110/150 124/156	80/36 80/36 80/36 80/36	150/68 150/68 150/68 150/68	
		— CU1526MA						
		— CU1526MW						
		— CU1526SA						
		— CU1526SW						
		— CU1526SW						
 26" x 27 3/8" x 33" 66.0 x 69.5 x 83.8 cm (Add 6" (15.2cm) Height for legs)	Med. Sm.	<b>CU2026</b>	Air Air Water	200/91 200/91 240/109	155/70 155/70 190/86	80/36 80/36 80/36	175/80 175/80 175/80	
		— CU2026MA						
		— CU2026SA						
		— CU2026SW						
 30" x 30" x 33" 76.2 x 76.2 x 83.8 cm (Add 6" (15.2cm) Height for legs)	Med. Sm.	<b>CU3030</b>	Air Air Water	250/114 250/114 310/141	217/98 217/98 285/129	110/50 110/50 110/50	200/91 200/91 200/91	
		— CU3030MA						
		— CU3030SA						
		— CU3030SW						
<b>Optional Kits</b>								
KPUFM26 KPUFM30		Kit - Prodigy® Undercounter Floor Mount for CU1526 & CU2026. Kit - Prodigy® Undercounter Floor Mount for CU3030.				3/1 3/1		

# Self Contained Gourmet Cubers



Unit Dimensions (W x D x H)	Model Number	Condenser Type	24 hr Ice Production		Storage Capacity lb/kg AHRI	Shipping Weight lb/kg
			70°F/21°C 50°F/10°C lb/kg	Air Water 90°F/32°C 70°F/21°C lb/kg		
 14 7/8" x 23 15/16" x 33 3/8" 37.78 x 60.80 x 84.77 cm	<b>CU50</b>	Air Air	65/30 65/30	50/23 50/23	26/12 26/12	100/45 105/48
	CU50GA CU50PA*					
 15 3/16" x 23 5/8" x 28 7/8" 38.6 x 60 x 73.3 cm (Add 5.25"(13.3cm) Height for legs)	<b>CU0515</b>	Air	84/38	66/30	24/11	95/43
	CU0515GA					

Standard exterior finish: Stainless Steel.  
 \*CU50PA-1A comes with a pump drain instead of a gravity drain.

# Prodigy Plus® Eclipse® Ice Machines



<b>EH222SL</b>  22" x 16.5" x 29" 55.9 x 41.9 x 71.1 cm	<b>EH330SL</b>  30" x 24" x 23" 76.2 x 61.0 x 58.4 cm	<b>EH430SL</b>  30" x 24" x 29" 76.2 x 61.0 x 71.1 cm
---	---	---

Cube Size	Model Number	Use With Condensing Unit	24 hr Ice Production		Shipping Weight lb/kg
			70°F/21°C 50°F/10°C lb/kg	Air Water 90°F/32°C 70°F/21°C lb/kg	
Sm.	<b>Ice Maker</b> EH222SL	ECC0800	850/386	700/318	215/98
		ECC1410	1030/468	865/393	225/102
Sm.	<b>Ice Maker</b> EH330SL	ECC1200	1330/604	1200/545	310/141
Sm./Med.	<b>Ice Maker</b> EH430SL / ML	ECC1410	1425/648	1200/545	225/102
		ECC1800	1775/807	1600/727	235/107

## ECC Features

- Energy efficient components save money on utility costs.
- Better corrosion resistance increases life of unit.
- One piece design makes installation and service easier.
- Maximizes air conditioning load.
- Allows for quiet operation in dining and working environments.
- Able to operate in wide outdoor temperature range from -20° F to 120° F.

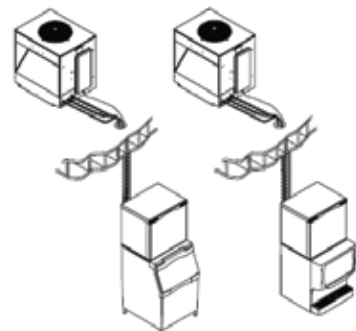

★ = Energy Star certified. ● = CE Approved.

8. Combine model number and electrical indicator when ordering for exact SKU, i.e. C0322MA-1. See page 16 for storage bins.



+



=

**Eclipse®**  
SYSTEM\*

Approx. Ice Production (lb.)	Ice Maker Small Cube	Ice Maker List Price	Condensing Unit
800	EH222SL	\$5,290	ECC0800
1000	EH222SL	\$5,290	ECC1410
1400	EH330SL	\$5,798	ECC1200
1400	EH430SL	\$6,027	ECC1410
1800	EH430SL	\$6,027	ECC1800

\*Line sets and bin top kits must be purchased with Eclipse® System for proper operation of equipment.

## Prodigy Plus® Eclipse® Condensing Unit

Unit Dimensions (W x D x H)	Model Number	Description	Shipping Weight lb/kg
 27" x 32.06" x 39.75" 68.58 x 81.4 x 100.9 cm	<b>Remote Condensers</b>		
	ECC0800	Remote condensing unit Eclipse 800 lb/364 kg systems	310/141
	ECC1200	Remote condensing unit Eclipse 1400 lb/636 kg systems	310/141
	ECC1410	Remote condensing unit Eclipse 1000-1400 lb /455-636 kg systems	310/141
	ECC1800	Remote condensing unit Eclipse 1800 lb/818 kg systems	310/141
<b>Miscellaneous</b>			
KSLT075	Suction line trap for locating icemaker more than 20ft (6.1m) below condenser unit.		1/1

## Prodigy Plus® Eclipse® Accessories

Model Number	Description	Shipping Weight lb/kg
<b>Line Sets</b>		
3BRTE20-EH	Line set, 20ft. Refrigerant and Brazing required.	21/10
3BRTE35-EH	Line set, 35ft. Refrigerant and Brazing required.	32/15
3BRTE50-EH	Line set, 50ft. Refrigerant and Brazing required.	53/24
3BRTE75-EH	Line set, 75ft. Refrigerant and Brazing required.	79/36
KTE6-EH	Kit, Tube End, 6 Fittings, 3RTExx-EH Lineset	5/2



☆ = Energy Star certified. ● = CE Approved.



Combine model number and electrical indicator when ordering for exact SKU, i.e. C0322MA-1. See page 16 for storage bins.

# Prodigy Plus® Modular Flake Ice Machines

\*Refer to page 18 & 20 for required bin tops.



Unit Dimensions (W x D x H)	Model Number	Condenser Type	24 hr Ice Production		Shipping Weight lb/kg	115/60/1 -1
			70°F/21°C 50°F/10°C lb/kg	Air Water 90°F/32°C 70°F/21°C lb/kg		
 22" x 24" x 23" 55.9 x 61.0 x 58.4 cm	<b>F0522</b>	Air Water	450/205 530/240	320/145 420/191	173/78 173/78	\$6,927 \$6,927
	F0522A					
	F0522W					
 22" x 24" x 23" 55.9 x 61.0 x 58.4 cm	<b>F0822</b>	Air Remote Water	800/363 760/345 775/352	580/263 610/277 600/272	175/79 175/79 175/79	\$8,802 \$8,702 \$8,802
	F0822A					
	F0822W					

Unit Dimensions (W x D x H)	Model Number	Condenser Type	24 hr Ice Production		Shipping Weight lb/kg
			70°F/21°C 50°F/10°C lb/kg	Air Water 90°F/32°C 70°F/21°C lb/kg	
 22" x 24" x 27" 55.9 x 61.0 x 68.6 cm	<b>F12222</b>	Air Remote Water	1000/454 1250/567 1240/562	825/374 1050/476 1040/472	220/100 220/100 220/100
	F1222A				
	F1222R F1222W				
 22" x 24" x 27" 55.9 x 61.0 x 68.6 cm	<b>F1522</b>	Air	1570/712	1100/499	224/102
	F1522A				

## Scotsman Nugget Ice®, The Original Chewable Ice®



Scotsman Ice Systems introduced the first Nugget ice machine in 1981 and today ice-chewing fanatics have embraced Nugget ice, which is soft and chewy. In fact, some of these chewers are looking for bags - not just cups - of Scotsman Nugget Ice®, creating a great opportunity for restaurants and convenience stores to add a new, high margin, repeat-business product customers really want. And Nugget ice makers from Scotsman can transform that opportunity into profit.

Beyond their crunch appeal, the slow-melting Nugget ice form cools drinks rapidly without foaming, and Nuggets displace more liquid than cube ice, lowering costs per cup. Nugget ice also consumes up to 50% less water and 15% less energy than cube machines. It all adds up to new customers, increased sales and a stronger bottom line.

☆ = Energy Star certified. ● = CE Approved.

10. Combine model number and electrical indicator when ordering for exact SKU, i.e. C0322MA-1. See page 16 for storage bins.





Unit Dimensions (W x D x H)	Model Number	Condenser Type	24 hr Ice Production		Shipping Weight lb/kg
			70°F/21°C 50°F/10°C lb/kg	Air Water 90°F/32°C 70°F/21°C lb/kg	
 22" x 24" x 23" 55.9 x 61.0 x 58.4 cm	<b>N0422</b>	Air Water	420/191 455/206	310/141 350/159	172/78 172/78
	N0422A N0422W				

Unit Dimensions (W x D x H)	Model Number	Condenser Type	24 hr Ice Production		Shipping Weight lb/kg
			70°F/21°C 50°F/10°C lb/kg	Air Water 90°F/32°C 70°F/21°C lb/kg	
 22" x 24" x 23" 55.9 x 61.0 x 58.4 cm	<b>N0622</b>	Air Remote Water	643/292 660/299 715/325	500/227 530/240 570/259	172/78 172/78 172/78
	N0622A N0622R N0622W				

Unit Dimensions (W x D x H)	Model Number	Condenser Type	24 hr Ice Production		Shipping Weight lb/kg
			70°F/21°C 50°F/10°C lb/kg	Air Water 90°F/32°C 70°F/21°C lb/kg	
 22" x 24" x 27" 55.9 x 61.0 x 68.6 cm	<b>N0922</b>	Air Remote Water	956/438 1044/474 1094/496	765/345 835/379 875/397	210/95 210/95 210/95
	N0922A N0922R N0922W				

Unit Dimensions (W x D x H)	Model Number	Condenser Type	24 hr Ice Production		Shipping Weight lb/kg
			70°F/21°C 50°F/10°C lb/kg	Air Water 90°F/32°C 70°F/21°C lb/kg	
 22" x 24" x 27" 55.9 x 61.0 x 68.6 cm	<b>N1322</b>	Air Remote Water	1180/535 1329/602 1354/614	950/431 1030/467 965/438	225/102 225/102 225/102
	N1322A N1322R N1322W				



# Prodigy Plus® Remote Low Side Flake and Nugget Complete Packages

\*Refer to page 18 & 20 for required bin tops.

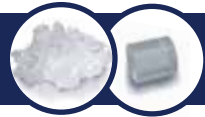

OR



+



=

Remote Low Side Flake and Nugget Complete Packages

Approx. Ice Production (lb.)	Flaker Ice Machine	Ice Maker List Price	Nugget Ice Maker	Ice Maker List Price	Condensing Unit
1000	F1222L	\$9,215	N0922L	\$9,762	NME954-RHS-A/C

# Prodigy Plus® Remote Low Side Flake and Nugget Complete Packages

\*Refer to page 18 & 20 for required bin tops.

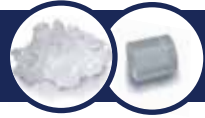

Unit Dimensions (W x D x H)	Model Number	Ice Form	24 hr Ice Production			Shipping Weight lb/kg
			70°F/21°C 50°F/10°C lb/kg	Air Water	90°F/32°C 70°F/21°C lb/kg	
 22" x 24" x 27" 55.9 x 61.0 x 68.6 cm	<b>Flaker</b>	Flake Flake	1180/535		1000/454	217/98
	F1222L		1445/655		1205/547	224/102
	<b>Nugget</b>	Nugget Nugget	1090/494		915/415	217/98
	N0922L		1330/605		1100/499	224/102
	N1322L					

# Modular and Remote Low Side Flake and Nugget Ice Machines

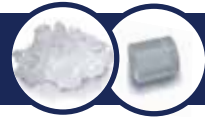

Unit Dimensions (W x D x H)	Model Number	Condenser Type	24 hr Ice Production			Shipping Weight lb/kg
			70°F/21°C 50°F/10°C lb/kg	Air Water	90°F/32°C 70°F/21°C lb/kg	
 42" x 24" x 27" 106.7 x 61.0 x 68.6 cm	<b>Flaker</b>	Air Remote Low Side	2455/1116		1400/635	425/193
	FME2404AS		2365/1075		2000/909	255/115
	<b>Nugget</b>	Remote	2185/993		1825/829	425/193
	NME1854RS					

# Remote Condensing Units for Remote Low Side Flake and Nugget Ice Machines

Unit Dimensions (W x D x H)	Model Number	Refrigerant	Description	Shipping Weight lb/kg
 29 1/2" x 28 5/8" x 38 1/2" 74.9 x 72.7 x 97.8 cm	<b>Remote Condensing Units</b> NME954-RHS-A/C	R-404A	Condensing Unit for N0922L and F1222L	220/87

☆ = Energy Star certified. ● = CE Approved.

12. Combine model number and electrical indicator when ordering for exact SKU, i.e. C0322MA-1. See page 16 for storage bins.

## Remote Low Side Flake and Nugget Accessories

Model Number	Description	Shipping Weight lb/kg
<b>Line Sets</b>		
NRTE45	45 ft. (13.7 m) non-precharged line set for remote low side flaker and nugget ice machines.	17/8

## Flake & Nugget® Ice Machine Kits and Accessories

Unit Dimensions (W x D x H)	Model Number	Description	Shipping Weight lb/kg
	<b>Remote Condensers</b>		
29 1/2" x 29 1/8" x 38 15/32" 74.9 x 74.0 x 97.7 cm	ERC111	Remote condenser for F0822R or N0622R	95/43
29 1/2" x 29 1/8" x 38 15/32" 74.9 x 74.0 x 97.7 cm	ERC311	Remote condenser for F1222R, N0922R or N1322R	130/59
28 1/2" x 39" x 34 5/8" 72.4 x 99.1 x 87.9 cm	PR2C240	Remote condenser for 2-F1222R, 2-N0922R, 1-NME1854R	135/61

Note: PR2C40-32A requires two line sets per ice machine when used with NME1854R; PRC2C240-32A requires two KPFHM kits when used with 2-F1222R or N0922R units.

Model Number	Description	Shipping Weight lb/kg
<b>Line Sets</b>		
RTE10	10 ft (3.0 m) precharged R-404A tubing	7/3
RTE25	25 ft (7.6 m) precharged R-404A tubing	12/5
RTE40	40 ft (12.2 m) precharged R-404A tubing	17/7
RTE75	75 ft (22.9 m) precharged R-404A tubing	35/15
KTE4	Tube end kit - Contains 4 quick connect fittings for any RTE Line Set	5/2
<b>Miscellaneous</b>		
KERCF	Air filter for ERC111 or ERC311	5/2
KPFHM	Headmaster Kit for use with ERC101, ERC151, ERC201, ERC302 or PR2C240	10/5
<b>Prodigy Modular Flaker &amp; Nugget Accessories</b>		
KPAS	Kit-Prodigy Advanced Sustainability. Includes KSBU-N and KVS	10/4
KSBU	Kit-Prodigy Smart-Board™ - Use additional operational data for fast diagnosis	5/2
KSBU-N	Kit-Prodigy Smart-Board™ - Network connection	5/2
KVS	Kit-Prodigy Vari-Smart™ Ice Level Control - Adjust ice levels to match ice needs	5/2

## Self-Contained Flake Ice Machines

Unit Dimensions (W x D x H)	Model Number	Condenser Type	24 hr Ice Production		Storage Capacity lb/kg AHRI	Shipping Weight lb/kg
			70°F/21°C 50°F/10°C lb/kg	Air Water 90°F/32°C 70°F/21°C lb/kg		
 24 1/4" x 24" x 33" 61.6 x 61.0 x 83.8 cm (add 6" (15.2 cm) Height for legs)	<b>AFE424</b>					
	AFE424A	Air	395/180	250/113	80/36	185/84
	AFE424W	Water	395/180	300/136	80/36	185/84
Standard exterior finish: Grey rotocast polyethylene.						



**HID312**



HID312A: 16.25" x 24.38" x 35"  
HID312AW: 18.25" x 24.38" x 35"

**HID525**



HID525A: 21.25" x 24.38" x 35"  
HID525AW: 23.25" x 24.38" x 35"  
HID525W: 21.25" x 24.38" x 35"

**HID540**



HID540A: 21.25" x 24.38" x 41"  
HID540AW: 23.25" x 24.38" x 41"  
HID525W: 21.25" x 24.38" x 41"

Model Number	Condenser Type	24 hr Ice Production		Storage Capacity lb/kg	Shipping Weight lb/kg
		70°F/21°C 50°F/10°C lb/kg	Air Water 90°F/32°C 70°F/21°C lb/kg		
<b>HID312</b>					
HID312A	Air	260/118	225/102	12/5	183/83
HID312AW*	Air	260/118	225/102	12/5	188/85
<b>HID525</b>					
HID525A	Air	500/227	365/166	25/11	208/94
HID525AW*	Air	500/227	365/166	25/11	213/97
HID525W	Water	500/227	400/181	25/11	208/94
<b>HID540</b>					
HID540A	Air	500/227	365/166	40/18	215/98
HID540AW*	Air	500/227	365/166	40/18	220/100
HID540W	Water	500/227	400/181	40/18	215/98
KLP24A	4" adjustable legs, plastic with metal foot (box of 4)				5/2

\*Wall mount configuration.

## Meridian™ Icemaker / Dispenser Stands

**HST16-A**



HST16-A: 16.8" x 23.75" x 32"\*  
55.4 x 60.3 x 81.3 cm

**HST16B-A**



HST16-A: 16.8" x 23.75" x 32"\*  
55.4 x 60.3 x 81.3 cm

**HST21-A**



HST21-A: 21.8" x 23.75" x 32"\*  
42.7 x 60.3 x 81.3 cm

**HST21B-A**



HST21-A: 21.8" x 23.75" x 32"\*  
42.7 x 60.3 x 81.3 cm

Model Number	Description	Shipping Weight lb/kg
<b>Dispenser Kits</b>		
HST16-A	Stand with door, use with HID312, SS, includes 6" legs	50/23
HST16B-A	Stand for HID312, basic version, SS, includes 6" legs	50/23
HST21-A	Stand with door, use with HID525 & HID540, SS, includes 6" legs	80/36
HST21B-A	Stand for HID525 & HID540, basic version, SS, includes 6" legs	80/36

\*Height includes 6" legs.

☆ = Energy Star certified. ● = CE Approved.

14. Combine model number and electrical indicator when ordering for exact SKU, i.e. C0322MA-1. See page 16 for storage bins.

# iceValet® Hotel / Motel Cube Dispensers

**HD22**



22" x 33 1/2" x 47 1/4"  
55.9 x 85.1 x 120.0 cm  
(add 6" (15.2 cm) Height for legs)

**HD30**



30" x 33 1/2" x 47 1/4"  
76.2 x 85.1 x 120.0 cm  
(add 6" (15.2 cm) Height for legs)

Model Number	Actuation	Storage Capacity lb/kg AHRI	Shipping Weight lb/kg
<b>HD22</b>	Push	120/59	200/91
HD22B			
<b>HD30</b>	Push Water Filler	180/81 180/81	220/100 225/102
HD30B HD30W			



## Ice Only Counter Top Dispensers

Unit Dimensions (W x D x H)	Model Number	Actuation	Storage Capacity lb/kg AHRI	Shipping Weight lb/kg
 ID150: 22" x 30" x 35 5/8" 55.9 x 76.2 x 90.5 cm ID200: 30" x 30" x 35 5/8" 76.2 x 76.2 x 90.5 cm ID250: 30" x 30" x 39 5/8" 76.2 x 76.2 x 100.6 cm	<b>Ice Only Dispensers</b>			
	ID150B	Cup Activated	150/68	150/68
	ID200B	Cup Activated	200/91	195/89
	ID250B	Cup Activated	250/114	200/91

# Ice Only Dispenser Kits and Accessories

Unit Dimensions (W x D x H)	Model Number	Description	Shipping Weight lb/kg
 IOBDMS22: 22" x 30" x 24" 55.9 x 76.2 x 61.0 cm  IOBDMS30: 30" x 30" x 24" 76.2 x 76.2 x 61.0 cm (add 6" (15.2 cm) Height for legs)	<b>Machine Stands</b>  IOBDMS22 IOBDMS30	Machine stand for ID150 Machine stand for ID200 & ID250	93/42 120/55
	<b>Kits</b>  KWGFID KNUGDIV	Field installed water glass filler kit for ID150, ID200, & ID250 Field installed nugget ice kit for all ID dispensers	2/1 1/0.5

# Storage Bins

Model Number	Storage Capacity lb/kg Maximum AHRI	Ext. Finish	Liner Material	Unit Dimensions (W x D x H)	Shipping Weight lb/kg	
 <b>Modular Bins</b>	B230P	242/110 190/86	Poly	Poly	30" x 32" x 28" (76.2 x 81.28 x 71.1 cm)	90/41
	B322S	370/168 290/132	Metallic	Poly	22" x 34" x 44" (55.9 x 86.4 x 111.8 cm)	140/64
	B330P	344/156 270/123	Poly	Poly	30" x 34" x 31" (76.2 x 86.4 x 78.7 cm)	90/41
	B530P	536/244 420/191	Poly	Poly	30" x 34" x 44" (76.2 x 86.4 x 111.8 cm)	110/50
	B530S	536/244 420/191	Metallic	Poly	30" x 34" x 44" (76.2 x 86.4 x 111.8 cm)	150/68
	B842S	778/353 610/277	Metallic	Poly	42" x 34" x 44" (106.7 x 86.4 x 111.8 cm)	185/84
	B948S	893/406 700/319	Metallic	Poly	48" x 34" x 44" (121.9 x 86.4 x 111.8 cm) Add 6" (15.2 cm) height for legs	220/100
 <b>BH Upright Modular Bins</b>	BH1100BB-A	1100/499 860/393	SS w/GBB*	Poly	48" x 34" x 50" (121.9 x 86.4 x 127.0 cm)	280/127
	BH1100SS-A	1100/499 860/393	SS	Poly	48" x 34" x 50" (121.9 x 86.4 x 127.0 cm)	280/127
	BH1300BB-A	1400/635 1100/499	SS w/GBB*	Poly	60" x 34" x 50" (152.4 x 86.4 x 127.0 cm)	320/145
	BH1300SS-A	1400/635 1100/499	SS	Poly	60" x 34" x 50" (152.4 x 86.4 x 127.0 cm)	320/145
	BH1600BB-A	1755/796 1375/624	SS w/GBB*	Poly	60" x 34" x 62" (152.4 x 86.4 x 157.5 cm)	370/168
	BH1600SS-A	1755/796 1375/624	SS	Poly	60" x 34" x 62" (152.4 x 86.4 x 157.5 cm) Add 6" (15.2 cm) height for legs	370/168

\* Stainless steel with galvanized back and bottom

Bins include adjustable bin top filler panels for use with most ice machines. (See machine bin sizing chart on back page for special configurations). No extra charge for special bin tops when ordered with new bin purchase, except for field installed kit KBT50 - KBT54 bin tops. See page 18 for purchase price for field installed bin tops.



☆ = Energy Star certified. ● = CE Approved.

16. Combine model number and electrical indicator when ordering for exact SKU, i.e. C0322MA-1. See page 16 for storage bins.

# Ice Express System Built-to-Order Only

Unit Dimensions (W x D x H)	Model Number	Description	Storage Capacity	Ext. Finish	Liner Material	Shipping Weight lb/kg
 <p>ICS-1 30" x 36" x 65" 76.2 x 91.4 x 165 cm ICS-2- 60" x 36" x 71" 152.4 x 91.4 x 180.3 cm ICS-2-SL 60" x 36" x 91" 152.4 x 91.4 x 231 cm ICS-3 90" x 36" x 71" 228.6 x 91.4 x 180.3 cm ICS-3-SL 90" x 36" x 101" 228.6 x 91.4 x 256.5 cm</p>	<b>Ice Express System</b>					
	ICS-1	1 Bay*	500/227	SS	Poly	320/145
	ICS-2	2 Bay*	1200/544	SS	Poly	530/241
	ICS-3	3 Bay*	1800/817	SS	SS	950/432
	ICS-3-SL	3 Bay with extension*	2900/1315	SS	SS	1190/541
	<b>Options</b>					
	ICS-PADDLE	Replacement paddle, white plastic	N/A	N/A	N/A	11/5
	ICS-SHOVEL	Shovel, white plastic	N/A	N/A	N/A	11/5
* Includes 1 poly cart for each bay. NOTE: All ICS systems & accessories ship F.O.B. Denver.						

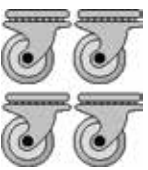
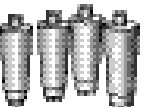
## Bin Accessories

Unit Dimensions (W x D x H)	Model Number	Description	Shipping Weight lb/kg			
	<b>Caster Kits</b>					
	KBC1	Bin caster kit for B530S, B842S, B948S, SB480, CU1526, CU2026, CU3030, BH bins and AFE [3.5" (8.9 cm) diameter wheels, 2 standard wheels and 2 locking. Raises bin 4 7/16" (11.3 cm)] - Not to be used with SB480 when using extension or B222S or B322S.	8/4			
	KBC1P	Bin caster kit for B330P and B530P. [3.5" (8.9 cm) diameter wheels, 2 standard wheels and 2 locking. Raises bin a maximum of 4 7/16" (11.3 cm).	20/9			
	<b>Leg Kits</b>					
	KLP7	Kit, legs, 6" black enamel, flanged feet, B Bins, HST stands, HD dispensers, AFE, CU0515, CU1526, CU2026 and CU3030.	5/2			
	KLP8S	Kit, legs, 6" stainless steel, Bx22, Bx30, B842, B948 and BH bins, HST stands, HD dispensers CU1526, CU2026, CU3030 and AFE. Note: Legs are supplied with self-contained machines, bins and machine stands.	5/2			
 <p>19 1/4" x 10 3/4" x 28 1/2" 48.9 x 27.3 x 72.4 cm</p>	<b>Ice Bagger</b>					
	BGS10	Hooks over any ice bin opening. Aluminum.	25/11			
	KBAG	Case of 1000 8lb bags.	30/14			
	KTAPE	One roll - 180 ft (54.9 m)	1/0.5			
	KSEALER	Tape sealer.	5/2			
Note: BGS10 includes easy bagger, wicket of bags (250), tape sealer and 1 roll of tape.						
	<b>Ice Scoop Holder</b>					
	KHOLDER	Stainless steel scoop holder. Fits all B330, B530, B842 and B948 ice storage bins	2/1			

## Bin Top Kits

Model Number	Description	Shipping Dimensions L x W x H	Use On	Shipping Weight lb/kg
KBT14A	NME1854, FME2404	10 x 27 x 5	B948	8/4
KBT22A	All 30" (76.2 cm) modular cubers, flakers or nugget makers	17 x 29 x 5	B948	11/5
KBT27	All 22" (55.9 cm) modular cubers, flakers or nugget makers except EH222	10 x 27 x 5	B230, B330, B530	8/4
KBT29	All 30" (76.2 cm) modular cubers	14 x 27 x 7	B842	10/5
KBT38	All 22" (55.9 cm) modular cubers, flakers and nugget makers except EH222	6 x 30 x 17	B948	14/7
KBT38-2X	All 22" (55.9 cm) modular cubers, flakers and nugget makers except EH222 side by side	10 x 27 x 5	B948	5/2
KBT39	All 22" (55.9 cm) modular cubers, flakers and nugget makers except EH222	14 x 27 x 7	B842	10/5
KBTABS	EH222	26 x 24 x 7	ABS	24/11
KBT40A	EH222	26 x 24 x 7	ID150	24/11
KBT41	EH222	32 x 32 x 5	ID200, ID250	25/11
KBT42	All 22" modular ice machines except EH222	31 x 33 x 5	ID150	12/5
KBT43	All 22" modular cubers and nugget makers except EH222	33 x 47 x 5	ID200, ID250	26/12
KBT44	All 30" modular cubers	32 x 33 x 2	ID200, ID250	13/5

## Field Installed - BH1100, BH1300, BH1600

Model Number	Description	Shipping Dimensions L x W x H	Use On	Shipping Weight lb/kg
KBT50	SS top for EH222	36 x 63 x 5	BH1100	80/36
KBT51	SS top for (2) 22" (55.9 cm) units side-by-side	36 x 63 x 5	BH1100	80/36
KBT52	SS top for EH222	36 x 63 x 5	BH1300, BH1600	80/36
KBT53	SS top for (2) 22" (55.9 cm) units side-by-side	36 x 63 x 5	BH1300, BH1600	80/36
KBT54	SS top for (2) 30" (76.2 cm) cubers side-by-side	36 x 63 x 5	BH1300, BH1600	80/36

## Accessory Kits

Model Number	Description	Shipping Weight lb/kg
<b>Prodigy Plus® Nugget Dispenser Accessory Kits</b>		
KDIL-PN-150	Kit, Ice Level Control with KVS, Prodigy Nugget on Cornelius DF or ED150	2/1
KDIL-PN-200	Kit, Ice Level Control with KVS, Prodigy Nugget on Cornelius DF or ED200	5/2
KDIL-PN-250	Kit, Ice Level Control with KVS, Prodigy Nugget on Cornelius DF or ED250	5/2
KDIL-PN-ID3	Kit, Ice Level Control with thermostat, Prodigy Nugget on Cornelius DF or ED300	2/1
KFSMF	Kit, manual fill nugget for Coca Cola Freestyle 9000 dispenser	3/1
KFSTM	Kit, top mounted nugget for Coca Cola Freestyle 9000 dispenser	3/1

★ = Energy Star certified. ● = CE Approved.

18. Combine model number and electrical indicator when ordering for exact SKU, i.e. C0322MA-1. See page 16 for storage bins.



# AquaDefense® System - Sanitation Solution

Unit Dimensions (W x D x H)	Model Number	Description	Shipping Weight lb/kg
	<b>AquaBullet® Anti Microbial Wand</b>	6 pack of Antimicrobial wands to prevent slime and mold build up. Used for modular cube ice machines.	5/2
	ADS-AB6		
AP1-P 5 5/8" x 4 3/4" x 21 1/2" 14.3 x 12.1 x 54.6 cm  AP2-P 16 1/2" x 5 1/2" x 19 1/4" 41.9 x 14.0 x 48.9 cm  AP3-P 21" x 5 1/2" x 19 1/4" 53.3 x 14.0 x 48.9 cm	<b>AquaPatrol™ Plus Water Filtration System</b>	Single system - Cubers up to 650 lb (395 kg), flakers, nuggets and nugget dispensers up to 1,200 lb (544 kg) Twin System - Cubers over 650 lb (295 kg), flakers and nuggets over 1,200 lb (544 kg) Triple System - Cubers over 1,300 lb (590 kg) Replacement cartridge (package of 6) Replacement cartridge (package of 1)	7/3 11/5 16/7 7/3 3/1.5
	AP1-P		
	AP2-P		
	AP3-P		
	APRC6-P APRC1-P		

## Water Filtration Systems By Everpure®

Unit Dimensions (W x D x H)	Model Number	Description	Shipping Weight lb/kg
SSM1 5 5/8" x 4 3/4" x 30 1/2" 14.3 x 12.1 x 77.5 cm  SSM2 16 1/2" x 5 1/2" x 25 1/2" 41.9 x 14.0 x 64.8 cm  SSM3 21" x 5 1/2" x 25 1/2" 53.3 x 14.0 x 64.8 cm	<b>SSM Plus Filtration Systems with AquaArmor by AgION®</b>	Single system - Cubers up to 650 lb (395 kg), flakers, nuggets and nugget dispensers up to 1,200 lb (544 kg) Twin System - Cubers over 650 lb (295 kg), flakers and nuggets over 1,200 lb (544 kg) Triple System - Cubers over 1,300 lb (590 kg)	7/3 11/5 16/7
	SSM1-P		
	SSM2-P		
	SSM3-P		
	<b>SSMRC Replacement Cartridges</b>	Single replacement cartridge (package of 1) 6 pack replacement cartridge (package of 6)	3/1.5 7/3
	SSMRC1 SSMRC6		
	<b>SC Coarse Prefilters</b>	10" (25.4 cm) Coarse prefilter 20" (50.8 cm) Coarse prefilter	5/2 11/5
	SC10-A SC20-A		
	<b>SC Replacement Prefilters</b>	SC10 replacement filter SC20 replacement filter	17/8 17/8
	SC10RC40 SC20RC20		



### Better Filtration for Clear, Pure Ice.

#### Water Filtration Systems

Assisting in the ice machine sanitation battle, the Scotsman Ice Systems AquaDefense® sanitation system is a common-sense multimethod approach to defending your ice machine against undesirable microbes, bacteria, mold and algae. The AquaDefense® sanitation system features advanced defensive means.

AquaPatrol Plus offers better protection now in a smaller footprint, higher capacity and better filtration capability.



# Machine/Bin Sizing Chart Dimensions in W x D x H - (Height includes 6" legs)

	BINS (Storage)	B322S	B230P	B330P	B530P/S	B842S	B948S	BH1100	BH1300	BH1600
ICE MAKERS (Production)	LBS	370	242	344	536	778	893	1100	1400	1755
<b>C0322</b> <b>C0522</b>	300 500	22" x 34" x 73" 55.9 x 86.4 x 185.4 cm	30" x 31" x 57" 76.2 x 78.7 x 144.8 cm w/KBT27 top	30" x 34" x 59" 76.2 x 86.4 x 149.9 cm w/KBT27 top	30" x 34" x 73" 76.2 x 86.4 x 185.4 cm w/KBT27 top	42" x 34" x 73" 106.2 x 86.4 x 185.4 cm w/KBT39 top	48" x 34" x 73" 121.9 x 86.4 x 185.4 cm w/KBT38 top or KBT38-2x - side by side			
<b>C0722</b>	700	22" x 34" x 76" 55.9 x 86.4 x 193.0 cm	30" x 31" x 63" 76.2 x 78.7 x 160.0 cm w/KBT27 top	30" x 34" x 65" 76.2 x 86.4 x 165.1 cm w/KBT27 top	30" x 34" x 79" 76.2 x 86.4 x 200.7 cm w/KBT27 top	42" x 34" x 79" 106.2 x 86.4 x 200.7 cm w/KBT39 top	48" x 34" x 79" 121.9 x 86.4 x 200.7 cm w/KBT38 top or KBT38-2x - side by side	48" x 34" x 87" 121.9 x 86.4 x 221.0 cm KBT51 - side by side	60" x 34" x 87" 152.4 x 86.4 x 221.0 cm KBT53 - side by side	60" x 34" x 99" 152.4 x 86.4 x 251.5 cm KBT53 - side by side
<b>C0330</b> <b>C0530</b> <b>C0630</b>	300 500 600		30" x 31" x 57" 76.2 x 78.7 x 144.8 cm	30" x 34" x 59" 76.2 x 86.4 x 149.9 cm	30" x 34" x 73" 76.2 x 86.4 x 185.4 cm	42" x 34" x 73" 106.7 x 86.4 x 185.4 cm w/KBT29 top	48" x 34" x 73" 121.9 x 86.4 x 185.4 cm w/KBT22A top			
<b>C0830</b> <b>C1030</b>	800 1000				30" x 34" x 79" 76.2 x 86.4 x 200.7 cm	42" x 34" x 79" 106.2 x 86.4 x 200.7 cm w/KBT29 top	48" x 34" x 79" 121.9 x 86.4 x 200.7 cm w/KBT22A top	48" x 34" x 85" 121.9 x 86.4 x 215.9 cm	60" x 34" x 85" 152.4 x 86.4 x 215.9 cm No bin top or KBT54 - side by side	60" x 34" x 97" 152.4 x 86.4 x 246.4 cm No bin top or KBT54 - side by side
<b>C1448</b> <b>C1848</b> <b>C2148</b>	1400 1800 2000						48" x 34" x 79" 121.9 x 86.4 x 200.7 cm	48" x 34" x 85" 121.9 x 86.4 x 215.9 cm	60" x 34" x 85" 152.4 x 86.4 x 215.9 cm	60" x 34" x 97" 152.4 x 86.4 x 246.4 cm
<b>C2648</b>	2600						48" x 34" x 84" 121.9 x 86.4 x 213.4 cm	48" x 34" x 90" 121.9 x 86.4 x 228.6 cm	60" x 34" x 90" 152.4 x 86.4 x 228.6 cm	60" x 34" x 102" 152.4 x 86.4 x 259.1 cm
<b>EH222</b>	800 1000							48" x 34" x 85" 121.9 x 86.4 x 215.9 cm KBT50 - single unit KBT51 - side by side	60" x 34" x 85" 152.4 x 86.4 x 215.9 cm KBT52 - single unit KBT53 - side by side	60" x 34" x 85" 152.4 x 86.4 x 215.9 cm KBT52 - single unit KBT53 - side by side
<b>EH330</b>	1400					42" x 34" x 73" 106.2 x 86.4 x 185.4 cm w/KBT29 top	48" x 34" x 73" 121.9 x 86.4 x 185.4 cm w/KBT22A top	48" x 34" x 79" 121.9 x 86.4 x 200.7 cm	60" x 34" x 79" 152.4 x 86.4 x 200.8 cm KBT54 - side by side	60" x 34" x 91" 152.4 x 86.4 x 231.1 cm No bin top or KBT54 - side by side
<b>EH430</b>	1400 1800					42" x 34" x 79" 106.2 x 86.4 x 200.7 cm w/KBT29 top	48" x 34" x 79" 121.9 x 86.4 x 200.7 cm w/KBT22A top	48" x 34" x 85" 121.9 x 86.4 x 215.9 cm	60" x 34" x 85" 152.4 x 86.4 x 215.9 cm KBT54 - side by side	60" x 34" x 97" 152.4 x 86.4 x 246.4 cm No bin top or KBT54 - side by side
<b>N0422</b> <b>N0622</b>	400 600	22" x 34" x 73" 55.9 x 86.4 x 184.4 cm	30" x 31" x 57" 76.2 x 78.7 x 144.8 cm w/KBT27 top	30" x 34" x 59" 76.2 x 86.4 x 149.9 cm w/KBT27 top	30" x 34" x 73" 76.2 x 86.4 x 185.4 cm w/KBT27 top	42" x 34" x 73" 106.2 x 86.4 x 185.4 cm w/KBT39 top	48" x 34" x 73" 121.9 x 86.4 x 185.4 cm w/KBT38 top or KBT38-2x - side by side			
<b>N0922</b> <b>N1322</b>	900 1300	22" x 34" x 77" 55.9 x 86.4 x 195.6 cm		30" x 34" x 63" 76.2 x 86.4 x 160.0 cm w/KBT27 top	30" x 34" x 77" 76.2 x 86.4 x 195.6 cm w/KBT27 top	42" x 34" x 77" 106.2 x 86.4 x 195.6 cm w/KBT39 top	48" x 34" x 77" 121.9 x 86.4 x 195.6 cm w/KBT38 top or KBT38-2x - side by side	48" x 34" x 85" 121.9 x 86.4 x 215.9 cm KBT51 - side by side	60" x 34" x 85" 152.4 x 86.4 x 215.9 cm KBT53 - side by side	60" x 34" x 97" 152.4 x 86.4 x 246.4 cm KBT53 - side by side
<b>F0522</b> <b>F0822</b>	500 800	22" x 34" x 73" 55.9 x 86.4 x 184.4 cm	30" x 31" x 57" 76.2 x 78.7 x 144.8 cm w/KBT27 top	30" x 34" x 59" 76.2 x 86.4 x 149.9 cm w/KBT27 top	30" x 34" x 73" 76.2 x 86.4 x 185.4 cm w/KBT27 top	42" x 34" x 73" 106.2 x 86.4 x 185.4 cm w/KBT39 top	48" x 34" x 73" 121.9 x 86.4 x 185.4 cm w/KBT38 top or KBT38-2x - side by side	48" x 34" x 81" 121.9 x 86.4 x 205.7 cm KBT51 - side by side	60" x 34" x 81" 152.4 x 86.4 x 205.7 cm KBT53 - side by side	60" x 34" x 93" 152.4 x 86.4 x 236.2 cm KBT53 - side by side
<b>F1222</b> <b>F1522</b>	1200 1500	22" x 34" x 77" 55.9 x 86.4 x 195.6 cm		30" x 34" x 63" 76.2 x 86.4 x 160.0 cm w/KBT27 top	30" x 34" x 77" 76.2 x 86.4 x 195.6 cm w/KBT27 top	42" x 34" x 77" 106.2 x 86.4 x 195.6 cm w/KBT39 top	48" x 34" x 77" 121.9 x 86.4 x 195.6 cm w/KBT38 top or KBT38-2x - side by side	48" x 34" x 85" 121.9 x 86.4 x 215.9 cm KBT51 - side by side	60" x 34" x 85" 152.4 x 86.4 x 215.9 cm KBT53 - side by side	60" x 34" x 97" 152.4 x 86.4 x 246.4 cm KBT53 - side by side
<b>NME1854</b>	1825					42" x 34" x 77" 106.2 x 86.4 x 195.6 cm	48" x 34" x 77" 121.9 x 86.4 x 195.6 cm w/KBT14A top	48" x 34" x 83" 121.9 x 86.4 x 210.8 cm	60" x 34" x 83" 152.4 x 86.4 x 210.8 cm	60" x 34" x 95" 152.4 x 86.4 x 241.3 cm
<b>FME2404</b>	2020					42" x 34" x 77" 106.2 x 86.4 x 195.6 cm	48" x 34" x 77" 121.9 x 86.4 x 195.6 cm w/KBT14A top	48" x 34" x 83" 121.9 x 86.4 x 210.8 cm	60" x 34" x 83" 152.4 x 86.4 x 210.8 cm	60" x 34" x 95" 152.4 x 86.4 x 241.3 cm

No bin top required when KBT not listed.

Ice Only Dispensers					Hotel D-Bins	
ABS	ID150	ID200	ID250	Cornelius ED300	HD22	HD30
150	150	200	250	300	120	180
	22" x 30 1/2" x 57 1/4" 55.9 x 77.5 x 145.4 cm w/KBT42 top	30" x 30 1/2" x 59" 76.2 x 77.5 x 149.9 cm w/KBT43 top	30" x 30 1/2" x 63" 76.2 x 77.5 x 160.0 cm w/KBT43 top		22" x 33 1/2" x 76 1/4" 55.9 x 85.1 x 193.7 cm	
	22" x 30 1/2" x 63 1/4" 55.9 x 77.5 x 160.7 cm w/KBT42 top	30" x 30 1/2" x 65" 76.2 x 77.5 x 165.1 cm w/KBT43 top	30" x 30 1/2" x 69" 76.2 x 77.5 x 175.3 cm w/KBT43 top		22" x 33 1/2" x 82 1/4" 55.9 x 85.1 x 208.9 cm	
		30" x 30 1/2" x 57 1/4" 76.2 x 77.5 x 145.4 cm w/KBT44 top	30" x 30 1/2" x 61 1/4" 76.2 x 77.5 x 155.6 cm w/KBT44 top	44" x 30 1/2" x 60" 112.7 x 77.5 x 152.4 cm w/Cornelius #629087943		30" x 33 1/2" x 76 1/4" 76.2 x 85.1 x 193.7 cm
		30" x 30 1/2" x 63 1/4" 76.2 x 77.5 x 160.7cm w/KBT44 top	30" x 30 1/2" x 67 1/4" 76.2 x 77.5 x 170.8 cm w/KBT44 top	44 1/2" x 30 1/2" x 66" 112.7 x 77.5 x 170.8 cm w/Cornelius #629087943		
KBTABS	22" x 30 1/2" x 64 1/4" 55.9 x 77.5 x 163.2 cm w/KBT40A top	30" x 30 1/2" x 64 1/2" 76.2 x 77.5 x 163.2 cm w/KBT41 top	30" x 30 1/2" x 68 1/4" 76.2 x 77.5 x 173.4 cm w/KBT41 top	44 1/2" x 30 1/2" x 66" 112.7 x 77.5 x 167.6 cm w/KBT45 top		
		30" x 30 1/2" x 57 1/2" 76.2 x 77.5 x 145.4 cm w/KBT44 top	30" x 30 1/2" x 61 1/4" 76.2 x 77.5 x 145.4 cm w/KBT44 top	44 1/2" x 30 1/2" x 60 1/4" 112.7 x 77.5 x 153 cm w/Cornelius #629087943		
		30" x 30 1/2" x 63 1/4" 76.2 x 77.5 x 160.7cm w/KBT44 top	30" x 30 1/2" x 67 1/4" 76.2 x 77.5 x 170.8 cm w/KBT44 top	44 1/2" x 30 1/2" x 66 1/4" 112.7 x 77.5 x 167.6 cm w/Cornelius #629087943		
	22" x 30 1/2" x 57 1/4" 55.9 x 77.5 x 145.4 cm w/KBT42 top KVS, KNUGDIV	30" x 30 1/2" x 59" 76.2 x 77.5 x 149.9 cm w/KBT43 top KVS, KNUGDIV	30" x 30 1/2" x 63" 76.2 x 77.5 x 160.0 cm w/KBT43 top KVS, KNUGDIV	44 1/2" x 30 1/2" x 64" 112.7 x 77.5 x 152.4 cm KDIL-PN-ID3 w/Cornelius #629087966 and #629088644		
	22" x 30 1/2" x 61 1/4" 55.9 x 77.5 x 155.6 cm w/KBT42 top KVS, KNUGDIV	30" x 30 1/2" x 63" 76.2 x 77.5 x 160.0 cm w/KBT43 top KVS, KNUGDIV	30" x 30 1/2" x 67" 76.2 x 77.5 x 170.2 cm w/KBT43 top KVS, KNUGDIV	44 1/2" x 30 1/2" x 64" 112.7 x 77.5 x 152.4 cm KDIL-PN-ID3 w/Cornelius #629087966 and #629088644		

# Ice Machine to Dispenser Kit Application Chart

Company	Dispenser	Ice Machines EH222	C0322/522/722	C0330/530/630/830 1030, EH330, EH430	N0422/622 922/1322
Cornelius	ED150	KBT40A	KBT42		KBT42 KDIL-PN-150
Cornelius	DF150	629087959*	02388*		02388* KDIL-PN-150
Cornelius	ED175	629087571*	629087907*		KDIL-PN-150 629087907*
Cornelius	ED200	KBT41	KBT43	KBT44	KBT43 KDIL-PN-200
	DF200	629087572*	08035*	08004*	
Cornelius	ED250	KBT41	KBT43	KBT44, KVS**	KBT43 KDIL-PN-250
	DF250	629087572	08035*	08004*, KVS**	
Cornelius	ED300	KBT45	08028*	629087943*	KDIL-PN-ID3 629087966* 629088644*
	DF300	KBT45	08028*	629087943*	
Cornelius	Flavor Fusion 255	629088666*	KVS** 629088502*	KVS** 629088505*	KVS 629088681* 629097086*
	IDC215/ID255	629088662*	KVS** 629088537*	KVS** 629088536*	KVS 629088677* 629097086*
Lancer	22" Wide	82-4063*	82-4062*		
Lancer	30" Wide	82-4061*	82-4060*	82-4059*, KVS**	
SerVend	S-150/SV-150	SL27-020000246*	SL30-020000249* CL10-5012116*		KVS SL30-020000249 CL10-5012116*
SerVend	SV-175	SL22-020000198*	SL24-020000200*		KVS SL24-020000200*
SerVend	S-200/SV-200 S-250/SV-250	SL17-5031150*	SL25-5031609*	N3-5031125* CL10-5012116*	KVS SL25-5031609*

\* Non Scotsman kits must be purchased from the dispenser manufacturer.

\*\* Recommended but not required.

- Please check with dispenser manufacturer for appropriate kits. Application chart subject to change.
- Blank cells indicate can not be used together, N/A indicates no adapter needed.
- See spare parts price list for Scotsman A37693-021 & R629088514 pricing.
- Lancer dispensers must be specially configured for dispensing Scotsman Nugget Ice®
- Some Cornelius adapters kits include binstats - do not use the thermostats.
- All Cornelius ED/DF adapter kits have grey doors/covers. Contact Cornelius for black.
- All Cornelius FlavorFusion adapter kits are midnight black. Contact Cornelius for silver, orange or green.
- All Cornelius IDC255 adapter kits are black.

# INTERNATIONAL PRODUCTS - Gourmet Modular Cubers



Unit Dimensions (W x D x H)	Cube Size	Model Number	Condenser Type	24 hr Ice Production		Shipping Weight lb/kg
				70°F/21°C 50°F/10°C lb/kg	Air Water 90°F/32°C 70°F/21°C lb/kg	
 <p><b>MC16</b> MC16: 30" x 24" x 28" 77.2 x 60.8 x 71 cm</p> <p><b>MC46</b> MC46: 42" x 21" x 34" 107.9 x 53.9 x 87.4 cm</p>	Med.	<b>MC16</b> — MCM516AS	Air	348/158	269/122	187/85
	Med. Lg.	<b>MC46</b> — MCM46AS — MCL46AS	Air Air	640/290 640/290	617/230 617/230	275/125 275/125

# INTERNATIONAL PRODUCTS - Gourmet Modular Cubers



<p><b>ACM56</b></p>  <p>15" x 23" x 27" 38.6 x 60 x 69.3 cm (add 5" (13.3 cm) Height for legs)</p>	<p><b>ACM126</b></p>  <p>26" x 23" x 36" 68 x 60 x 93 cm (add 3" (9 cm) Height for legs)</p>	<p><b>ACM176</b></p>  <p>26" x 23" x 39" 68 x 60 x 100 cm (add 3" (9 cm) Height for legs)</p>
---	---	--

Model Number	Condenser Type	24 hr Ice Production		Storage Capacity lb/kg Maximum	Shipping Weight lb/kg
		70°F/21°C 50°F/10°C lb/kg	Air Water 90°F/32°C 70°F/21°C lb/kg		
<b>ACM56</b>	Air	67/31	53/24	27/13	95/43
ACM56AS					
<b>ACM126</b>	Air	149/68	124/56	86/39	165/75
ACM126AS					
<b>ACM176</b>	Air	178/81	152/69	106/48	175/80
ACM176AS					

Standard exterior finish: stainless steel \* Price includes legs

# INTERNATIONAL PRODUCTS - Storage Bins

Model Number	Storage Capacity lb/kg Maximum	Ext. Finish	Linear Material	Unit Dimensions (W x D x H)	Shipping Weight lb/kg



## International Warranty

- MC and bin models: 2 year parts, 1 year labor
- AC models: 3 year parts, 2 year labor



## Please Note:

- Items are FOB Scotsman Ice (Italy)
- **Not qualified for installation in North America**